



Diadema



Electra



Maia



Sirio



Aureo

PROFILI LED E ACCESSORI

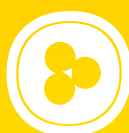

Revolution light design

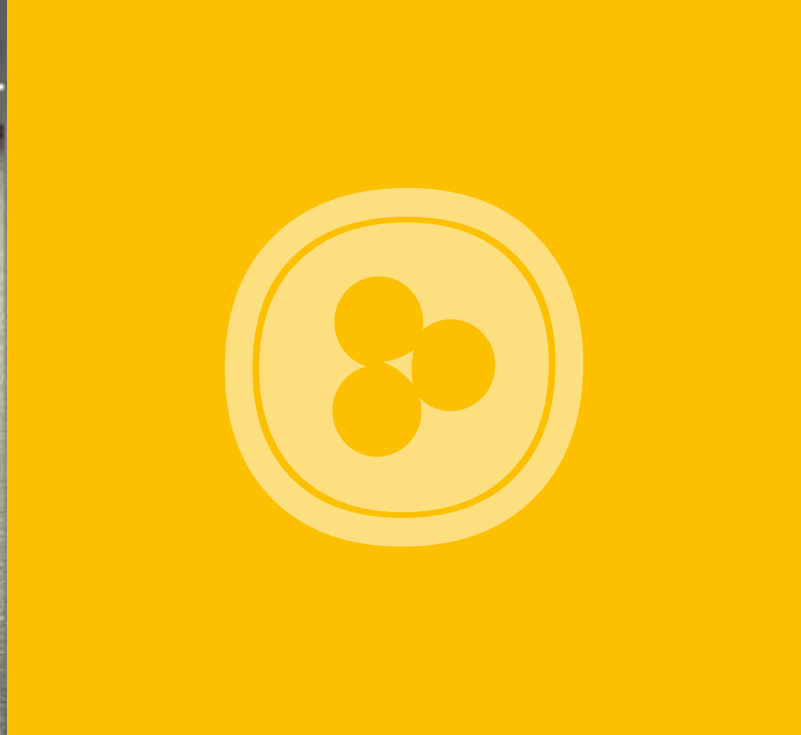

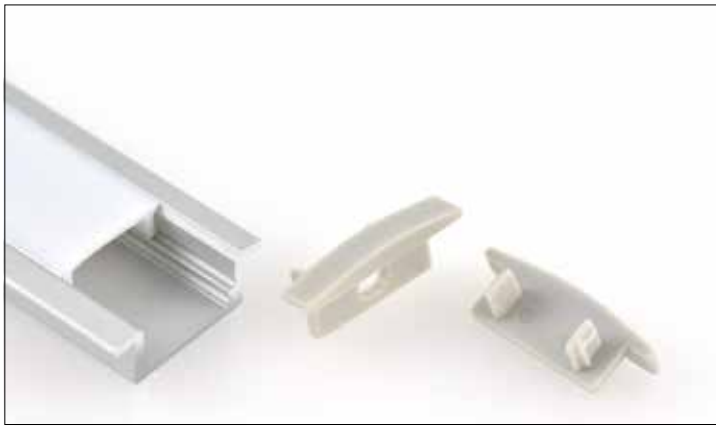

Diadema

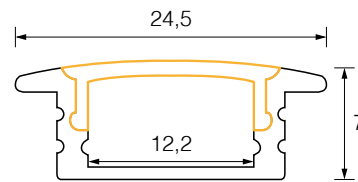

codice | code

RVLPR100O-R
RVLPR101S-R

modello | model

Opale Opal
Semitrasparente Translucent

misure | measure 24,5x7x2000 mm

disegno tecnico | technical drawing

CARATTERISTICHE | FEATURES

Profilo profile	Alluminio anodizzato argento	Silver anodized aluminium
Lunghezza length	2 Metri (altre misure su richiesta)	2 metres (other lengths on request)
Materiale diffusore diffuser materials	PC (Policarbonato)	PC (Polycarbonate)
Materiale tappi cap materials	PC (Policarbonato)	PC (Polycarbonate)
Modalità di fissaggio mounting method	Resine silicomiche adatte allo specifico materiale	silicone resins suitable to the specific material
Accessori accessories	Tappo iniziale, tappo terminale	start cap, end cap
Led strip consigliato Recommended strip led	Qualsiasi tipologia con larghezza massima di 12mm;	any type of LED strip with a maximum width of 12mm;

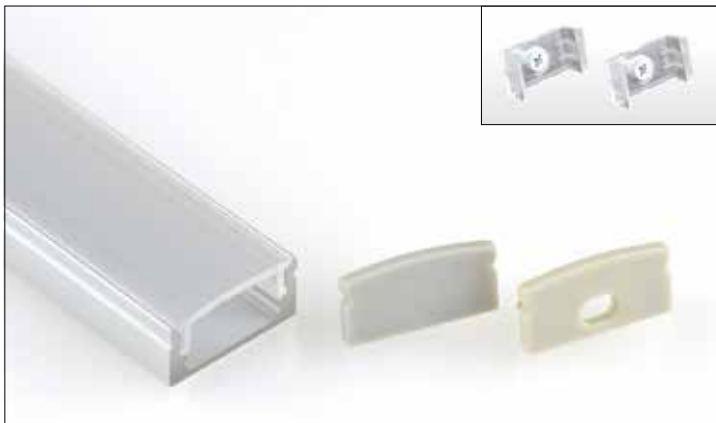

Electra

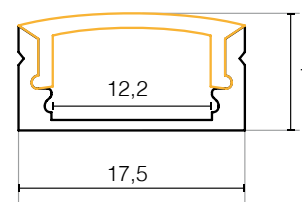

codice | code

RVLPR103O-R
RVLPR104S-R

modello | model

Opale Opal
Semitrasparente Translucent

misure | measure 17,5x7x2000 mm

disegno tecnico | technical drawing

CARATTERISTICHE | FEATURES

Profilo profile	Alluminio anodizzato argento	Silver anodized aluminium
Lunghezza length	2 Metri (altre misure su richiesta)	2 metres (other lengths on request)
Materiale diffusore diffuser materials	PC (Policarbonato)	PC (Polycarbonate)
Materiale tappi cap materials	PC (Policarbonato)	PC (Polycarbonate)
Modalità di fissaggio mounting method	Clips, viti, resine silicomiche	clips, screws, silicone resins
Accessori accessories	Tappo iniziale, tappo terminale, clip di montaggio	start cap, end cap, mounting clips
Led strip consigliato Recommended strip led	Qualsiasi tipologia con larghezza massima di 12mm;	any type of LED strip with a maximum width of 12mm;



Maia

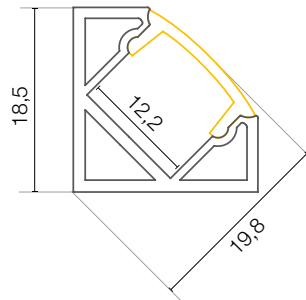

 **misure** | measure 18,5x18,5x2000 mm

disegno tecnico | technical drawing

codice | code

RVLPR1150

RVLPR116S

modello | model

Opale Opal

Semitrasparente Translucent

CARATTERISTICHE | FEATURES

Profilo | profile

Lunghezza | length

Materiale diffusore | diffuser materials

Materiale tappi | cap materials

Modalità di fissaggio | mounting method

Accessori | accessories

Led strip consigliato | Recommended strip led

Alluminio anodizzato argento

2 Metri (altre misure su richiesta)

PC (Policarbonato)

PC (Policarbonato)

Clips, viti

Tappo iniziale, tappo terminale, clips di montaggio

Qualsiasi tipologia con larghezza massima di 12 mm

Silver anodized aluminium

2 metres (other lengths on request)

PC (Polycarbonate)

PC (Polycarbonate)

clips, screw

start cap, end cap, mounting clips

any type of LED strip with a maximum width of 12mm;



Sirio

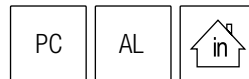
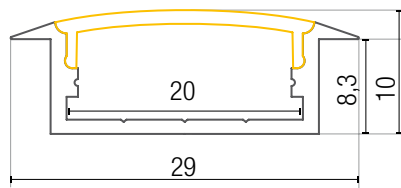

 **misure** | measure 29x10x2000 mm

disegno tecnico | technical drawing

codice | code

RVLPR124O

modello | model

Opale Opal

CARATTERISTICHE | FEATURES

Profilo | profile

Lunghezza | length

Materiale diffusore | diffuser materials

Materiale tappi | cap materials

Modalità di fissaggio | mounting method

Accessori | accessories

Led strip consigliato | recommended strip led

Alluminio anodizzato argento

2 Metri (altre misure su richiesta)

PC (Policarbonato)

PC (Policarbonato)

Resine siliciche adatte allo specifico materiale, viti

Tappo iniziale, tappo terminale

doppia striscia LED

Silver anodized aluminium

2 metres (other lengths on request)

PC (Polycarbonate)

PC (Polycarbonate)

silicone resins suitable to the specific material, screw

start cap, end cap, mounting clips

double strip LED

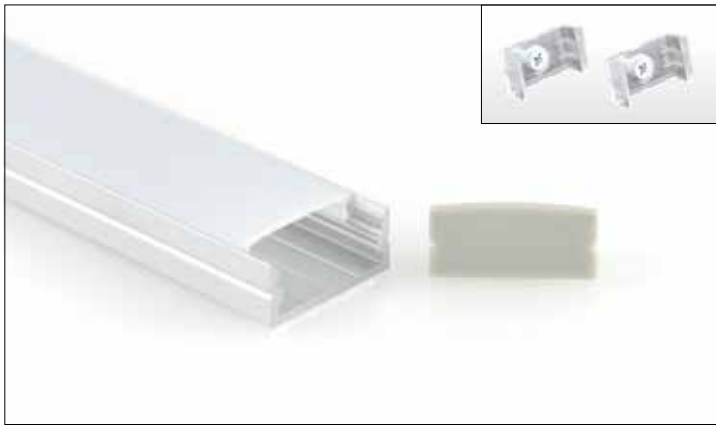

Aureo

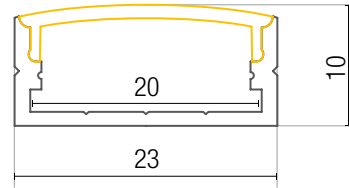

codice | code

modello | model

RVLPR127O

Opale Opal

misure | measure 23x10x2000 mm

disegno tecnico | technical drawing

CARATTERISTICHE | FEATURES

Profilo profile	Alluminio anodizzato argento	Silver anodized aluminium
Lunghezza length	2 Metri (altre misure su richiesta)	2 metres (other lengths on request)
Materiale diffusore diffuser materials	PC (Policarbonato)	PC (Polycarbonate)
Materiale tappi cap materials	PC (Policarbonato)	PC (Polycarbonate)
Modalità di fissaggio mounting method	Clips di montaggio, viti, resine siliciche	mounting clips, screws, silicone resins
Accessori accessories	Tappo iniziale, tappo terminale, clips di montaggio	start cap, end cap, mounting clips
Led strip consigliato Recommended strip led	doppia striscia led	double strip LED

ACCESSORI

TAPPI



€ 0,64

codice | code

Descrizione | Description

RVLTP-DIADEMA	Tappo per profilo Diadema	Diadema end cap profile
RVLTP-ELECTRA	Tappo per profilo Electra	Electra end cap profile
RVLTP-MAIA	Tappo per profilo Maia	Maia end cap profile
RVLTP-SIRIO	Tappo per profilo Sirio	Sirio end cap profile
RVLTP-AUREO	Tappo per profilo Aureo	Aureo end cap profile

SUPPORTI DI MONTAGGIO A PARETE

Compatibile con ELECTRA, MAIA, AUREO



€ 0,39

codice | code

Descrizione | Description

RVLSP-ELECTRA	Supporto per profilo Electra	Diadema support profile
RVLSP-MAIA	Supporto per profilo Maia	Electra support profile
RVLSP-AUREO	Supporto per profilo Aureo	Maia support profile

PROFILI

Diadema



Codice	Descrizione	Confezione	Prezzo
RVLPR100O-R	Profilo in alluminio anodizzato da incasso, con diffusore in policarbonato opale, barra 2m	10	€ 22,80
RVLPR101S-R	Profilo in alluminio anodizzato da incasso, con diffusore in policarbonato satinato, barra 2m	10	€ 22,80
RVLTP-DIADEMA	Tappo per profilo Diadema	10	€ 0,64

Electra



Codice	Descrizione	Confezione	Prezzo
RVLPR103O-R	Profilo in alluminio anodizzato sovrapposto con diffusore in policarbonato opale, barra 2m	10	€ 20,40
RVLPR104S-R	Profilo in alluminio anodizzato sovrapposto con diffusore in policarbonato satinato, barra 2m	10	€ 20,40
RVLTP-ELECTRA	Tappo per profilo Electra	10	€ 0,64
RVLSP-ELECTRA	Supporto di fissaggio per profilo Electra	1	€ 0,39

Maia



Codice	Descrizione	Confezione	Prezzo
RVLPR115O	Profilo in alluminio anodizzato angolare, con diffusore in policarbonato opale, barra 2m	10	€ 25,56
RVLPR116S	Profilo in alluminio anodizzato angolare, con diffusore in policarbonato satinato, barra 2m	10	€ 25,56
RVLTP-MAIA	Tappo per profilo Maia	10	€ 0,64
RVLSP-MAIA	Supporto di fissaggio per profilo Maia	1	€ 0,39

Sirio



Codice	Descrizione	Confezione	Prezzo
RVLPR124O	Profilo in alluminio anodizzato da incasso, con diffusore in policarbonato opale, barra 2m	10	€ 41,00
RVLTP-SIRIO	Tappo per profilo Sirio	10	€ 0,64

Aureo





Codice	Descrizione	Confezione	Prezzo
RVLPR127O	Profilo in alluminio anodizzato sovrapposto, con diffusore in policarbonato opale, barra 2m	10	€ 39,00
RVLTP-AUREO	Tappo per profilo Aureo	10	€ 0,64
RVLSP-AUREO	Supporto di fissaggio per profilo Aureo	1	€ 0,39

STRIP LED 24V

	Strip Led 3528 SMD - IP20							
	Cod.	watt/roll (5 m)	watt/m	led/m	Colore	A/roll	lumen (Lm/led)	prezzo € / roll
	RVLST1412024W	24	4,8	60	cool white 6000K	1A	7	€ 33,00
	RVLST1422024NW	24	4,8	60	natural white 4000K	1A	7	€ 33,00
	RVLST1432024WW	24	4,8	60	warm white 3000K	1A	7	€ 33,00
	RVLST1512048W	48	9,6	120	cool white 6000K	2A	7	€ 53,00
	RVLST1522048NW	48	9,6	120	natural white 4000K	2A	7	€ 53,00
	RVLST1532048WW	48	9,6	120	warm white 3000K	2A	7	€ 53,00
	RVLST1372096WW	96	19,2	240	warm white 3000K	4A	7	€ 115,00
	RVLST1382096NW	96	19,2	240	natural white 4000K	4A	7	€ 115,00
	RVLST1392096W	96	19,2	240	cool white 6000K	4A	7	€ 115,00
Strip Led 3528 SMD - IP65								
	RVLST1416524W	24	4,8	60	cool white 6000K	1A	7	€ 43,00
	RVLST1426524NW	24	4,8	60	natural white 4000K	1A	7	€ 43,00
	RVLST1436524WW	24	4,8	60	warm white 3000K	1A	7	€ 43,00
	RVLST1516548W	48	9,6	120	cool white 6000K	2A	7	€ 63,00
	RVLST1526548NW	48	9,6	120	natural white 4000K	2A	7	€ 63,00
	RVLST1536548WW	48	9,6	120	warm white 3000K	2A	7	€ 63,00

	Strip Led 5050 SMD - IP20							
	Cod.	watt/roll (5 m)	watt/m	led/m	Colore	A/roll	lumen (Lm/led)	prezzo € / roll
	RVLST1612072W	72	14,4	60	cool white 6000K	3A	20	€ 68,00
	RVLST1622072NW	72	14,4	60	natural white 4000K	3A	20	€ 68,00
	RVLST1632072WW	72	14,4	60	warm white 3000K	3A	20	€ 68,00
Strip Led 5050 SMD - IP65								
	RVLST1616572W	72	14,4	60	cool white 6000K	3A	20	€ 88,00
	RVLST1626572NW	72	14,4	60	natural white 4000K	3A	20	€ 88,00
	RVLST1636572WW	72	14,4	60	warm white 3000K	3A	20	€ 88,00

	Strip Led 5050 SMD - IP20							
	Cod.	watt/roll (5 m)	watt/m	led/m	Colore	A/roll	lumen (Lm/led)	prezzo € / roll
	RVLST171150RGB	150	30	96	RGB + NW 4000K	6,25A	20	€ 186,00

	RVLST171150RGB	Controller LED RGB + NW - 12-24V DC - IP20						€ 54,60
--	----------------	--	--	--	--	--	--	---------

ALIMENTATORI 24 VDC

	ULTRA SLIM PC							
	Cod.	Vdc	Tensione ingresso	Potenza Max (W)	Corrente Max (A)	Dimensioni (mm)	IP	prezzo
	RVLAL2132415	24	200~240V AC	15	0,6 A	100 x 30 x 22	40	€ 15,00
	RVLAL2142435	24	200~240V AC	35	1,5 A	145 x 38 x 22	40	€ 25,00
	RVLAL2152460	24	200~240V AC	60	2,5 A	176 x 43 x 25	40	€ 35,00

	ULTRA SLIM ALLUMINIO							
	Cod.	Vdc	Tensione ingresso	Potenza Max (W)	Corrente Max (A)	Dimensioni (mm)	IP	prezzo
	RVLAL21624100	24	200~240V AC	100	4,1 A	112 x 87 x 34	20	€ 40,00
	RVLAL21724150	24	200~240V AC	150	6,25 A	160 x 87 x 34	20	€ 45,00
	RVLAL21824200	24	200~240V AC	200	8,3 A	223 x 70 x 39	20	€ 65,00
	RVLAL21924250	24	200~240V AC	250	10,4 A	223 x 70 x 39	20	€ 85,00



Brand di Contact Italia, **Revoled** è specializzata nella produzione della moderna illuminazione a led in ambito civile e commerciale. Offre prodotti di illuminazione non solo per uso abitativo, ma anche per uffici, punti vendita, showroom, hotel, musei, centri di bellezza e altre location.

Sensibile alle attuali tematiche di risparmio energetico, **Revoled** offre ai clienti un ventaglio di soluzioni innovative nel massimo rispetto dell'ambiente e della sostenibilità.

I prodotti Revoled sono disponibili presso:



Revoled utilizza 100% energia verde



Questa brochure è interamente realizzata con carta ecologica, a PH neutro ed esente da cloro e metalli pesanti.